

AC Servo Drive AD Series

For the highest requirements in performance and precision

HITACHI

Inspire the Next

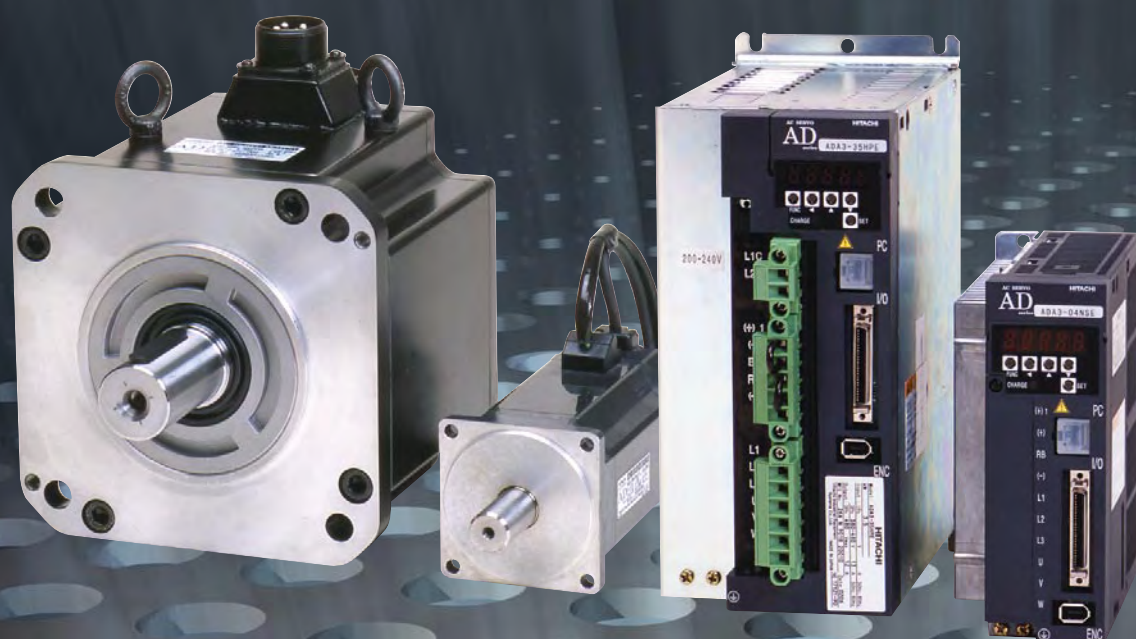

- Range of Performance 0.1 kW – 7 kW (0.32 – 33.4 Nm)
- Drastically Reduced Motor Cogging Torque
- Advanced Drive Technology
- Autotuning
- Built-in Programmable Sequence with max. 512 program steps and 100 positions
- Plug & Play
- Easy programming
- Position / Speed / Torque control
- DeviceNet, SERCOS, Modbus
- CE, UL, c-UL

AC Servo Drive AD Series

For the highest requirements in performance and precision

High Performance – with AC Servo Drives from Hitachi

Hitachi AD Series AC Servo Drives meet the various requirements of demanding applications with its fully featured performance realised by Hitachi's Advanced Motor Technology. Using Autotuning, control gains can be automatically tuned to the optimum values according to each application.

In connection with the Hitachi Motion-Controller EH-POS4 it is possible to control up to 4 axis.

All Servo motors are available with holding brake.

The ADMA series (100-750 W) is equipped with a serial Encoder (17 bit). These systems are able to identify the connected motor – an additional adjustment from the amplifier according to the motor is not necessary.



Drastically Reduced Motor Cogging Torque

With Hitachi's Advanced Motor technology (patented), motor cogging torque has been reduced by approx. 65 % (comparison with our previous model).

The AD Series Servo Drive is suitable for such applications as high-precision process machine or smart conveyer system where vibration should be avoided.

Example of 0.75 kW standard motor

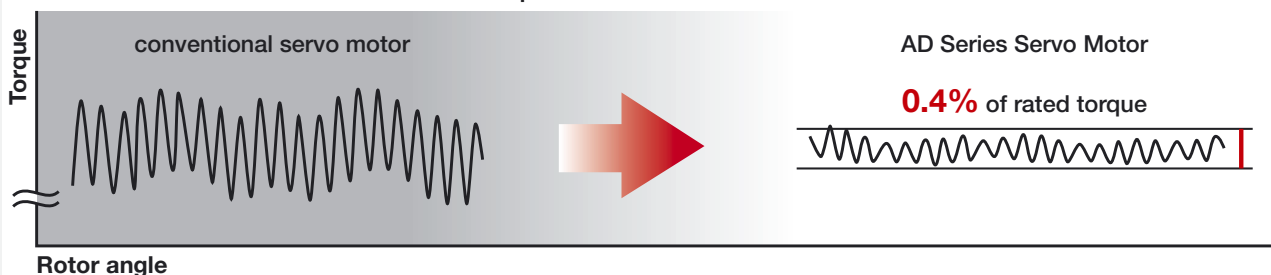

High Response and High precision

High-precision positioning and stable rotation at low speed can be realised with 32-bit system LSI with DSP, which assures speed response frequency of 500Hz with a high-resolution of 17 bits.

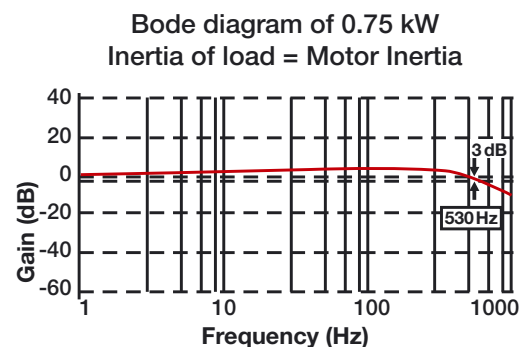

Smart Servo Drive

The programming software AHF allows simple programming and a very short time for commissioning – even for novice users. The Servo Amplifier ADAX4 has a standard integrated programming function for max. 512 program steps and 100 positions.

For stand-alone applications an additional controller is not necessary.

The programming language is like BASIC®

- 6kB instructions ~ 1000 steps
- 7 different reference points
- 12 Digital-Inputs
- 8 Digital-Outputs
- 2 Analog-Inputs
- 2 Analog-Outputs
- 100 Positions
- 16 Velocity Settings
- 16 Torque Settings
- 16 General Variables
- Password protection (8 characters or numbers)
- General purpose parameters changeable via digital operator
- Trips can be handled by the programmable function
- Programmable Timer
- Speedcontrol / Positioncontrol / Torquecontrol etc.

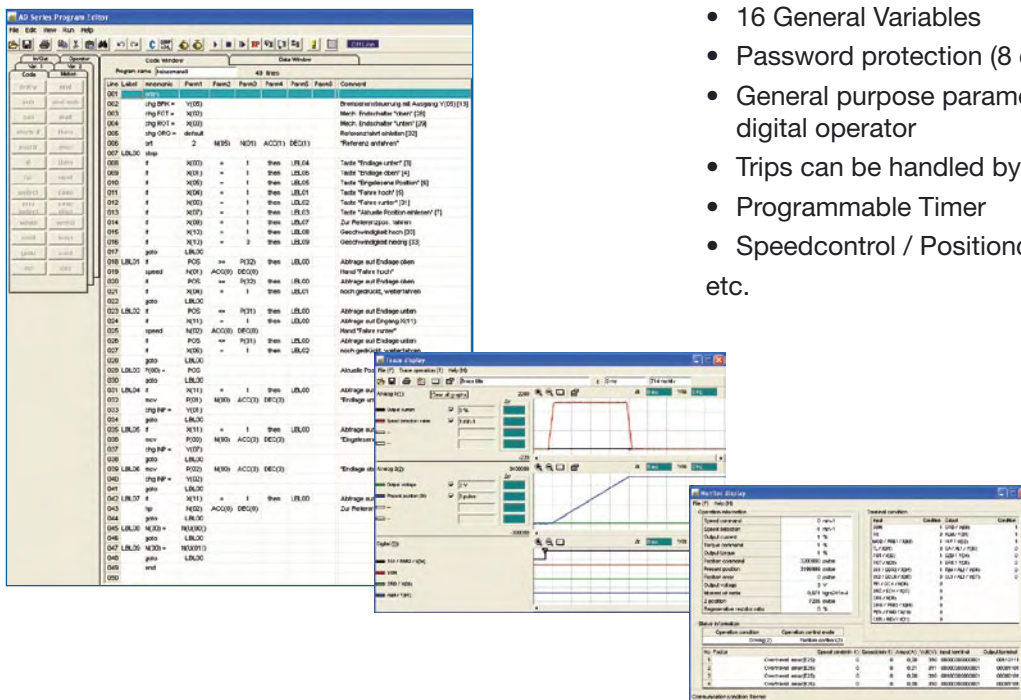

User Friendliness

Windows PC-Software AHF

Through use of the AHF configuration software, which runs on Windows operating system, parameters can be set through a personal computer and position, speed, torque etc. of the AC servo drive can be monitored on the PC display.

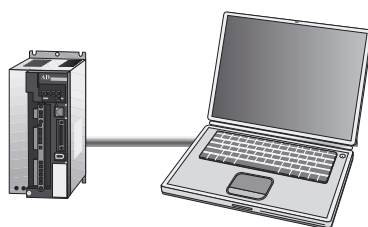

Autotuning Function

Control gains can be automatically tuned to the optimum values according to each application.

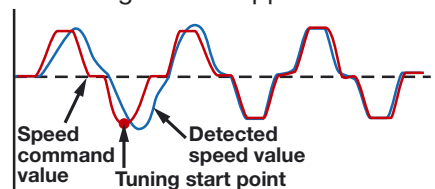

Worldwide Presence

Your benefit is the high quality of the Hitachi products and the worldwide presence of one of the world's biggest electronics companies.



AC Servo Drive AD Series

For the highest requirements in performance and precision

HITACHI
Inspire the Next

ADAX4 as "Stand Alone" unit

- Programming
- Test run and adjustment
- Trace operation
- Online read and write of general purpose parameters

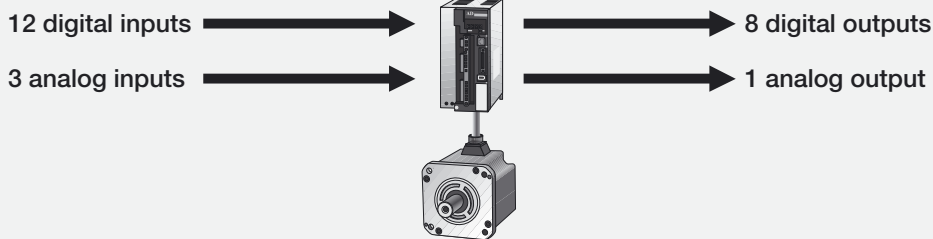
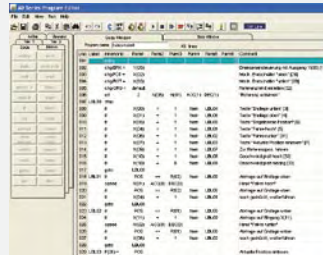
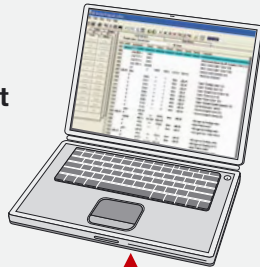

ADAX4 (Modbus model)

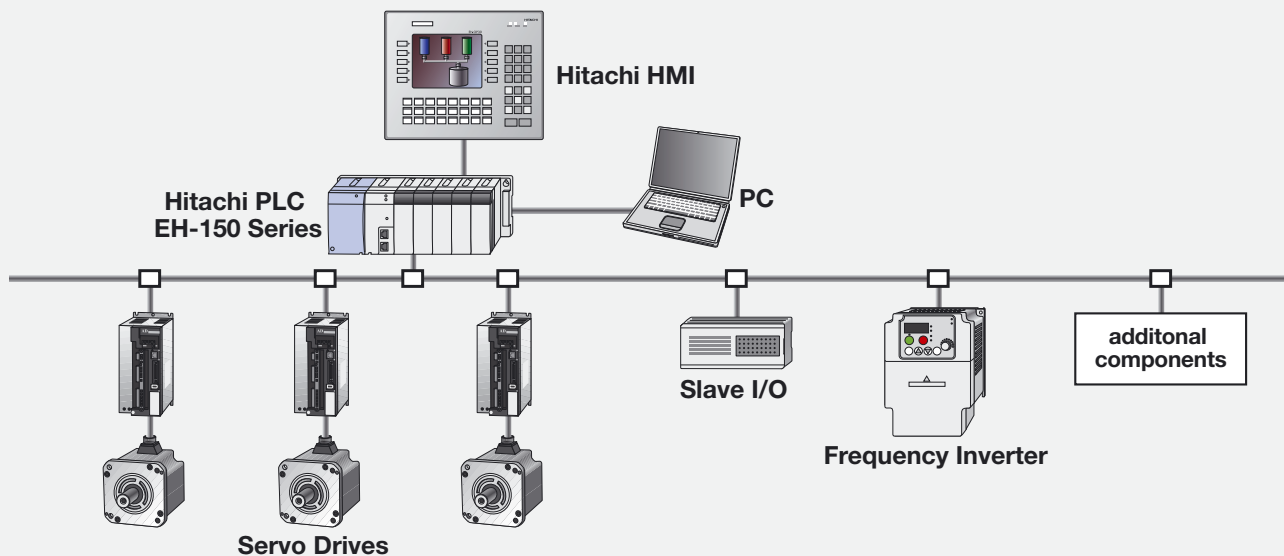

ADAX4 (Motion Control Model)

Controlled by PLC EH-150 with EH-POS4 (4 axis pulse positioning control module)

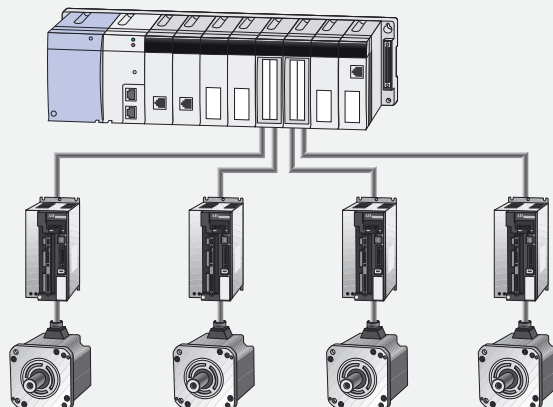

Specifications of Servo Motors

		1 x 230 V / 3 x 200 V				3 x 400 V							
		ADMA-				ADMG-							
Input power supply	Motor-Type	01S	02S	04S	08S	05H	10H	15H	20H	35H	45H	55H	70H
Amplifier-Type		ADAX4				ADAX4							
		01NSE	02NSE	04NSE	08NSE	15HPE			35HPE		70HPE		
Motor capacity	kW	0.1	0.2	0.4	0.75	0.5	1.0	1.5	2.0	3.5	4.5	5.5	7.0
Rated torque	Nm	0.32	0.64	1.27	2.39	2.4	5	7.5	9.55	16.7	21.5	26.3	33.4
Max. torque	Nm	0.96	1.91	3.82	7.16	9	18.5	20	30	45.5	70	72	86
Rated speed	Nm	3000				2000							
Max. Speed	min ⁻¹	4500				3000							
JMotor	kgm ²	0.023	0.12	0.22	0.62	1.84	5.40	8.80	11.8	37.9	46.5	113.5	185
(above: without brake; below: with brake)	x 10 ⁻⁴	0.032	0.16	0.25	0.71	2.18	5.85	9.30	12.3	41.3	49.9	137.5	209
Preferrable Load Inertia		max. 30 x J _{Motor}				max. 5 x J _{Motor}							
Feedback		Serial Encoder 17 bit				Incremental encoder							
		(Optional: 17 bit absolute value encoder)				4096 ppr				8192 ppr			
Protection		IP55 (excluding connector and the part passed through by the shaft)				IP67 (excluding the part passed through by the shaft)							

Brake

Principle		Electromechanical brake, release when activated											
Power supply		DC 24 V, ±10 %						DC 24 V, ±10 %					
Static brake torque (min.)	Nm	0.34	1.5	1.5	2.6	2.9	9.8	9.0	12	32	32	90	90
Rated current (20 °C)	A	0.27	0.27	0.27	0.38	0.33	0.83	0.87	1.0	1.4	1.4	1.3	1.3
Resistor of the coil (20 °C)	ohm	89	89	89	64	72	28	28	23	17	17	18	18
Power consumption (20 °C)	W	6.5	6.5	6.5	9.0	8.0	20	21	25	34	34	32	32
Dragging (max.)	ms	25	60	60	50	30	100	100	100	150	150	300	300
Release time (max.)	ms	20	10	10	15	20	30	30	30	40	40	140	140

Specifications of Servo Motors

Type	Performance	L	LL	LR	LE	LG	LC	LA	LZ	S	LB	T	U	W	LK	Tapping size	KA	Fig.	weight
ADMA-01...A1x1	100 W	122	96.5	25	2.5	5	40	46	4.5	8	30	3	1.8	3	14	M3 x 6	-	A	0.55
ADMA-01...A1x3		157	132																0.8
ADMA-02...A1x1	200 W	130	100	30	3	7	60	70	5.5	14	50	5	3	5	20	M5 x 8	-	C	1.1
ADMA-02...A1x3		168	138																1.7
ADMA-04...A1x1	400 W	158	128	40	3	8	75	90	6.6	19	70	6	3.5	6	22	M5 x 8	-	-	1.6
ADMA-04...A1x3		196	166																2.2
ADMA-08...A1x1	750 W	183	143	40	3	8	75	90	6.6	19	70	6	3.5	6	22	M5 x 8	-	-	3.1
ADMA-08...A1x3		220	180																3.9

Last digit 1: without brake, 3: with brake

Type	Performance	L	LL	LR	LE	LG	LC	LA	LZ	S	LB	T	U	W	LK	Tapping size	KA	Fig.	weight
ADMG-05HP142	0.5 kW	228	193	35	3	8	86	100	6.6	16	80	5	3	5	25	M5 x 12	2	B	3.0
ADMG-05HP145		263	228																4.2
ADMG-10HP142	1 kW	241	196	45	3	10	100	115	9	22	95	6	3.5	6	32	M6 x 20	3	D	5.4
ADMG-10HP145		276	231																6.8
ADMG-15HP142	1.5 kW	224	169	55	4	12	130	145	9	22	110	6	3.5	6	42	M6 x 20	3	-	7.8
ADMG-15HP145		260	205																9.4
ADMG-20HP142	2 kW	242	187	55	4	12	130	145	9	28	110	7	4	8	42	M8 x 25	3	-	9.8
ADMG-20HP145		282	227																11.6
ADMG-35HP142	3.5 kW	268	203	65	3	16	180	200	13.5	35	114.3	8	5	10	50	M8 x 25	3	-	17.7
ADMG-35HP145		318	253																23.1
ADMG-45HP142	4.5 kW	283	218	65	3	16	180	200	13.5	35	114.3	8	5	10	50	M8 x 25	3	-	21.7
ADMG-45HP145		333	268																27.1
ADMG-55HP142	5.5 kW	331	252	79	4	19	220	235	13.5	55	200	10	6	16	67	M10 x 25	3	-	34.8
ADMG-55HP145		388	309																45.5
ADMG-70HP142	7 kW	389	310	79	4	19	220	235	13.5	55	200	10	6	16	67	M10 x 25	3	-	52.8
ADMG-70HP145		447	368																63.5

Last digit 2: without brake, 5: with brake

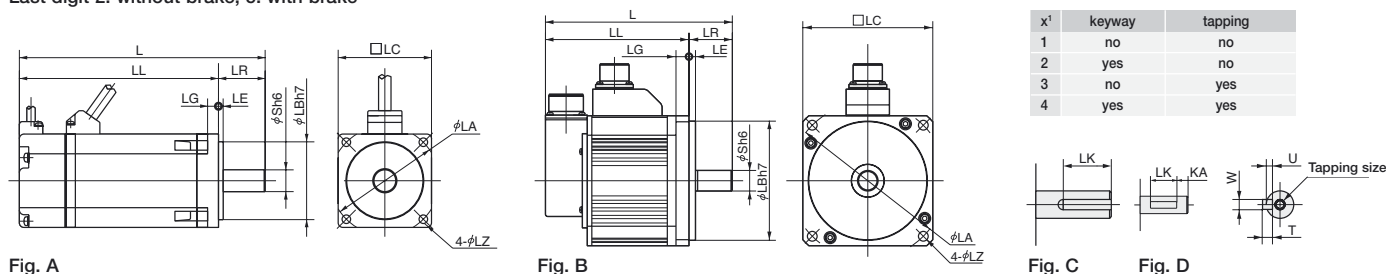

Fig. A

Fig. B

Fig. C

Fig. D

AC Servo Drive AD Series

For the highest requirements in performance and precision

Technical Data of the Amplifier

Type: ADAX4	01NSE	02NSE	04NSE	08NSE	15HPE			35HPE		70HPE		
Motor capacity (kW)	0.1	0.2	0.4	0.75	0.5	1.0	1.5	2.0	3.5	4.5	5.5	7.0
Input power supply capacity (kVA)	0.4	0.75	1.2	2.3	1.2	1.8	2.5	3.5	5.6	6.8	8.3	11
Input power supply (main circuit)	1 x 220...230 V / 3 x 200...230 V +10 %, -15%				3 x 380...480 V +10 %, -15 %, 50/60 Hz ±5 %							
Input control power supply	1 x 200...230 V +10 %, -15 %				1 x 200...240 V +10 %, -15 %, 50/60 Hz ±5 %							
Rated speed (min ⁻¹)	3000				2000							
Max. Speed (min ⁻¹)	4500				3000							
Max. torque (Ratio to the rated torque)	300 %				250 % – 380 % (see motor specification for detail)							
Position/speed feedback	Serial Encoder 17 bit, optional absolute encoder				Incremental encoder, absolute encoder (Serial output)							
Speed control range	1:4500				1:3000							
Position command input	Line driver signal (2M pulses/s or less) Selectable from 1) – 3) 1) Phase difference pulse input (maximum input frequency is 1/4 of the value above noted) 2) Forward/reverse run direction pulse input 3) Command pulse + code input											
Input signal	Contact signal/open collector signals inputs: Servo ON, Program-Start, Alarm reset, Control mode switch, Torque limit, Forward overtravel, Reverse overtravel, Multistage speed 1, Multistage speed 2, Proportional control/exchange gains, Zero speed clamp, Homing limit switch, Homing, pulse train input enable/forward command, Position error clear/reverse command											
Output signal	Source type output: Servo ready, Alarm, Positioning complete, Up to speed/alarm code 1, Zero speed detection, Brake release, Torque limiting/alarm code 2, Overload notice/alarm code 3											
Regenerative braking circuit	Build-in type (Braking resistor not included for 01NSE, 02NSE)											
Dynamic brake	Actuated at Servo OFF, Trip or Power OFF (operating conditions selectable)											
Protective function	Overcurrent, braking resistor overload, over voltage, EEPROM, CPU, undervoltage, CT error, ground fault, encoder Abnormal position, output stage, external error, Abnormal revolution, temperature, absolute encoder, etc.											
Estimated weight (kg)	0.8	0.8	1.4	1.9	1.9	4.6	4.6	7.7	7.7	7.7	7.7	7.7
Ambient temperature	0...+55 °C											
Humidity	max. 90 % (without condensation)											
Vibration (Note 2)	5.9 m/s ² (0.6 G), 10 to 55 Hz (according JIS C0040)											
Installation location	1000 m or less above the sea, indoor place (free from corrosive gas and dust)											
Protective structure	IP00, according JEM 1030											
Control system	Sine-wave pulse width modulation PWM system											
Control mode	Position control/speed control/torque control											
Built-in operator	5-digit number display unit, key input x 5											
Programming software	AHF, usable for Windows® 95/98/ME, Windows® NT/2000/XP PC (RS-232C)											
Encoder monitor signal output	Phase A, B signal output: Line driver (output resolution adjustable) Phase Z signal output: Open Collector											
Analog outputs	2ch, 0...3 V, Voltage output, Speed detection value, Torque commnd, etc.											
Speed command/limitation input	0...10 V											
Torque command/limitation input	0...10 V											

ADMA-01S

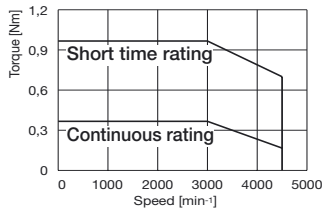

ADMA-02S

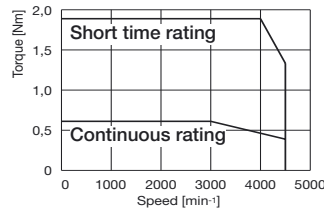

ADMA-04S

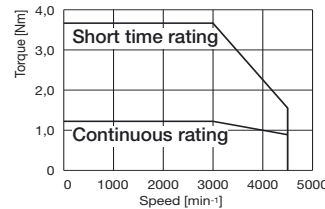

ADMA-08S

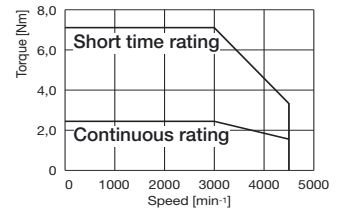

ADMG-05H

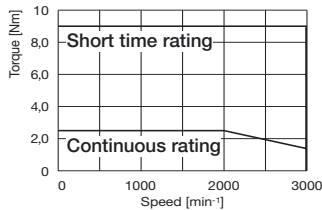

ADMG-10H

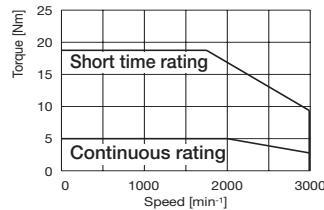

ADMG-15H

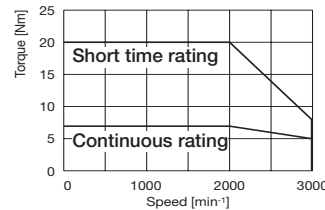

ADMG-20H

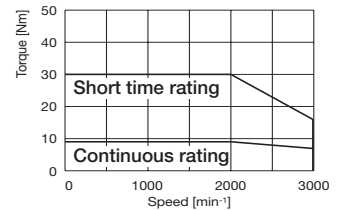

ADMG-35H

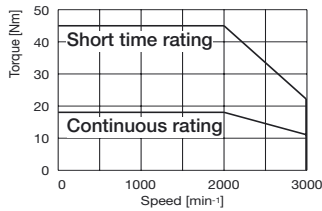

ADMG-45H

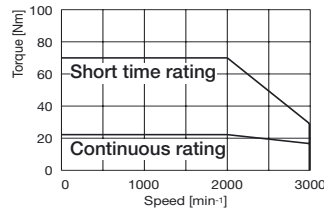

ADMG-55H

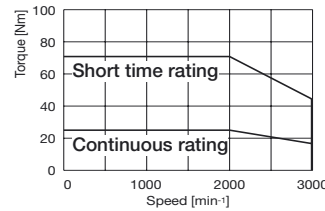

ADMG-70H

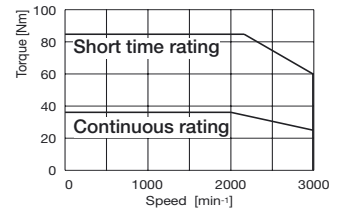

Hitachi Europe GmbH

Am Seestern 18 · D-40547 Düsseldorf
Tel. +49-211-52 83 -0 · Fax +49-211-52 83 -649
Internet: www.hitachi-ds.com
E-Mail: info@hitachi-ds.com